



## **GARRETT VENT | EXTERNAL WASTEGATES**

High-flowing external wastegates for performance engines  
Valve Sizes: 40mm 45mm 50mm 60mm



Garrett Vent | External Wastegates regulate turbocharger shaft speed by venting exhaust gas around the turbine stage of the turbocharger. CFD optimized design maximizes flow and delivers optimum boost control. Advanced thermal optimization increases durability of the diaphragm. The cap design makes spring changes and serviceability of the entire GVW lineup easier and more reliable to perform.

**Garrett**  
ADVANCING MOTION



# GARRETT VENT | EXTERNAL WASTEGATES

High-flowing external wastegates for performance engines

Garrett Vent | External wastegates are created by the engineers that designed G-Series and GTX Gen II turbochargers. Available in four sizes: 40mm | 45mm | 50mm | 60mm and four color combinations: Red | Blue | Black | Silver. The valve housing is cast from high temp stainless steel and rated for exhaust temperatures up to 1050° C. CFD optimized for maximum flow and thermal efficiency. Our Nomex reinforced elastomer diaphragm provides exceptional durability and fatigue resistance.

GVW wastegates are set to 1 Bar | 14.5 PSI of base pressure and can be configured from 0.2 Bar | 2.9 PSI - 1.7 Bar | 24.7 PSI (considering 1:1 backpressure). The actuator design allows for multiple air/liquid fitting orientations. All fasteners, springs, fittings, V-bands, clamps, and flanges included. For pricing and availability please contact an authorized distributor.

Model	Base Pressure	Red	Blue	Black	Silver
GVW-40	1 Bar   14.5 PSI	908827-0001	908827-0002	908827-0003	908827-0004
GVW-45	1 Bar   14.5 PSI	908828-0001	908828-0002	908828-0003	908828-0004
GVW-50	1 Bar   14.5 PSI	908829-0001	908829-0002	908829-0003	908829-0004
GVW-60	1 Bar   14.5 PSI	908830-0001	908830-0002	908830-0003	908830-0004

## Features:

- CFD tested for maximum flow and thermal efficiency
- Optimized actuation stability and temperature resistance for superior durability
- Replaceable valve and bushing components to increase service life
- Robust design for easy diaphragm replacement
- Liquid-cooled actuator ports for use on severe applications (up to 52% reduction in body temp)
- Anodized aluminum actuator cover



Mechanical Data	GVW-40	GVW-45	GVW-50	GVW-60
Valve Diameter	40mm	45mm	50mm	60mm
Valve Mass	1.27kg   45oz	1.47kg   52oz	1.56kg   55oz	1.74kg   61oz
Max Spring Base Pressure	1.7 bar   25 psi (1:1 backpressure ratio)			
Minimum Spring Base Pressure	0.2 bar   3 psi (1:1 backpressure ratio)			
Port Fitting: Air	M10x1.0 to hose barb (Hose ID 6mm   .25in)			
Port Fitting: Liquid	M8x1.0 to AN-3			

Material Data	GVW-40   GVW-45   GVW-50   GVW-60
Valve Housing	High temp stainless steel rated up to 1050°C
Diaphragm	High temp Nomex reinforced elastomer
Actuator Cover	Fully-machined anodized 6061 aluminum
Valve Guide/Bushing	Nitronic 60
Valve	High temp stainless steel with plated stem
V-Band	CNC machined 304 stainless steel
Flanges	Fully-machined 304 stainless steel
Springs	17/7 PH stainless steel

Thermal Data	GVW-40   GVW-45   GVW-50   GVW-60
Max Thermal Stress (Non-Cooled)	270°C actuator body temp during thermal cycle test
Max Thermal Stress (Liquid-Cooled)	130°C actuator body temp during thermal cycle test
Max Exhaust Temp: Peak	Up to 1050°C



# GARRETT VENT | EXTERNAL WASTEGATES

## Flow Data

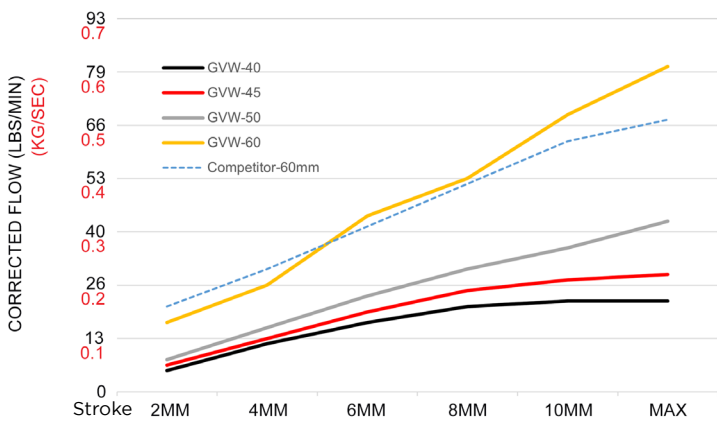

## Actuation Durability Test Data

When researching and testing common shortfalls of wastegates, we observed how heat cycling and normal wear can rapidly change their actuation characteristics. Garrett engineers created GVW as a high flowing product with low degradation in performance over its lifespan.

Actuation data (opening and closing) in the chart was measured before and after extreme testing conditions. Results show the heat cycled GVW product maintains linear control of the wastegate as compared to the new product.

Precise actuation of the GVW provides accurate calibration settings and performance throughout the lifespan of the product. Accurate wastegates, allow for optimum performance of the turbocharger.

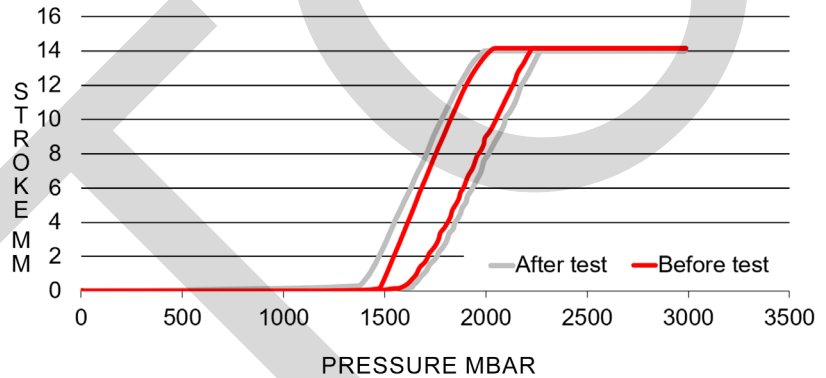

## Spring Pressure Chart

	PSI	3	4	6	7	9	10	12	13	Base Pressure	16	17	19	20	22	23	25
<b>GVW-40</b>	Bar	0.2	0.3	0.4	0.5	0.6	0.7	0.8	0.9	14.5	1.1	1.2	1.3	1.4	1.5	1.6	1.7
Red		x					x	x			x						
Blue			x						x	x		x			x	x	x
Green				x			x		x				x			x	
White					x			x						x	x		x
Brown						x				x					x		
Purple										x	x	x	x	x		x	x
<b>GVW-45</b>	PSI	3	4	6	7	9	10	12	13	14.5	16	17	19	20	22	23	
<b>GVW-50</b>	Bar	0.2	0.3	0.4	0.5	0.6	0.7	0.8	0.9	1	1.1	1.2	1.3	1.4	1.5	1.6	
Blue		x				x	x		x	x	x				x	x	
Green			x						x			x	x		x		
White				x		x		x		x				x		x	
Brown					x		x	x	x	x	x	x					
Purple											x	x	x	x	x	x	
Black											x	x	x	x	x	x	
<b>GVW-60</b>	PSI	3	4	6	7	9	10	12	13	14.5	16	17	19	20	22	23	
	Bar	0.2	0.3	0.4	0.5	0.6	0.7	0.8	0.9	1	1.1	1.2	1.3	1.4	1.5	1.6	
Red							x	x					x			x	
Blue		x							x					x			
Green			x							x					x	x	
White					x		x					x	x	x	x	x	
Brown				x							x						
Purple						x		x	x	x	x	x	x	x	x	x	

Spring pressures are calculated based on a 1:1 boost/backpressure ratio. Actual intake manifold (boost) pressure can vary



# GARRETT VENT | EXTERNAL WASTEGATES

## Ancillary Part Chart | Tightening Torque Specs

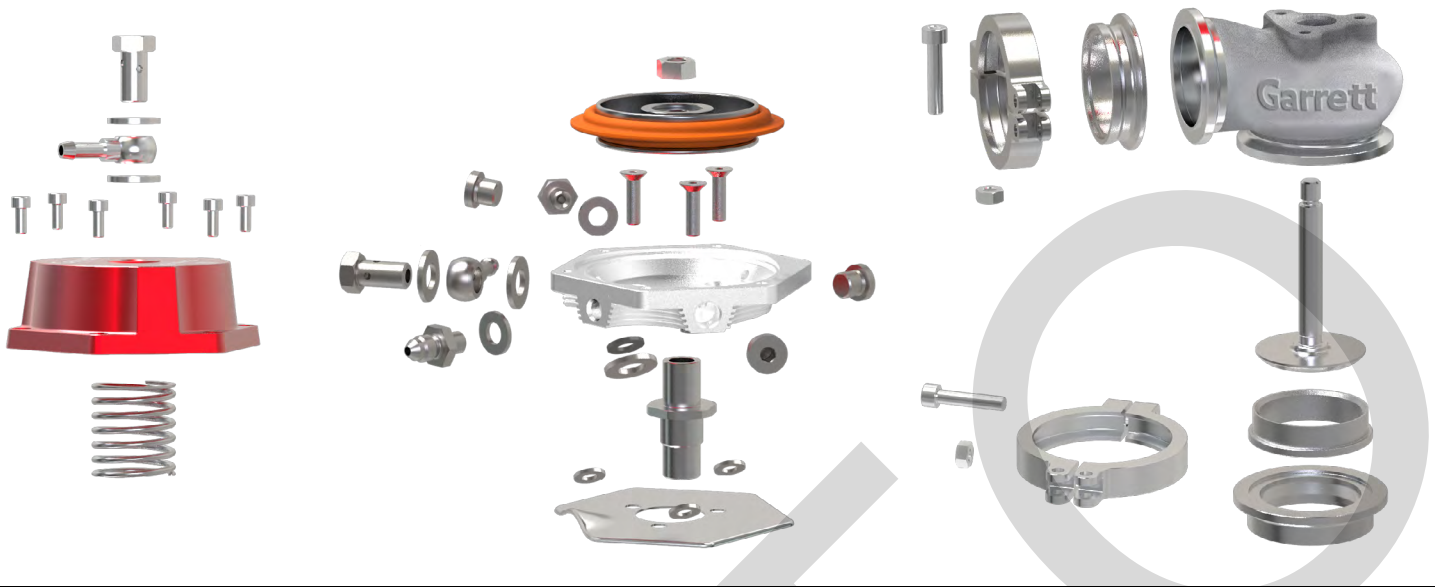

Description	Tightening Torque Nm   ft-lb	GVW-40	GVW-45	GVW-50	GVW-60
Kit: Air Fitting (Banjo Fitting, Bolt, 2 Crush Washers)	15   11		910477-0001		
Kit: Diaphragm (Diaphragm Assy, Valve Stem Nut)	10   7	910476-0001	910476-0002		910476-0003
Kit: Valve/Bushing (Valve,Bushing,Seal Washer,O-Ring,Valve Stem Nut,Seat)	10   7	910478-0001	910478-0002	910478-0003	910478-0004
Kit: V-Band Inlet (V-Band, Bolt, Locknut)	15   11	910475-0001	910475-0003	910475-0004	910475-0005
Kit: V-Band Outlet (V-Band, Bolt, Locknut)	15   11	910475-0002	910475-0001	910475-0003	910475-0006
Bolt, Actuator Body	5   4		Bolt Not Available		
Bolt, Actuator Cap	2.5   2.0		894537-0001		
Bolt, V-band	N/A		894540-0006		
Bolt, Banjo Fitting	15   11		Included In Air Fitting Kit		
Bushing	30   22		Included In Valve/Bushing Kit		
Fitting, Water 8mm	10   7		895520-0001		
Fitting, Plug Air 10mm	15   11		895519-0001		
Flange, Inlet Weld	N/A	894649-0003	894649-0001	894649-0007	894649-0005
Flange, Outlet Weld	N/A	894649-0004	894649-0002	894649-0008	894649-0006
Locknut, V-band	15   11		905694-0001		
Nut, Valve	10   7		Included In Valve/Bushing Kit		
Seat, Valve	N/A	894648-0002	894648-0001	894648-0004	894648-0003
Spring, Red (See Spring Chart For Spring Pressure)	N/A	898344-0001			
Spring, Blue (See Spring Chart For Spring Pressure)	N/A		898344-0002		
Spring, Green (See Spring Chart For Spring Pressure)	N/A		898344-0003		
Spring, White (See Spring Chart For Spring Pressure)	N/A		898344-0004		
Spring, Brown (See Spring Chart For Spring Pressure)	N/A		898344-0005		
Spring, Purple (See Spring Chart For Spring Pressure)	N/A		898344-0006		
Spring, Black (See Spring Chart For Spring Pressure)	N/A		898344-0008		
Washer, Crush 8mm	N/A		895518-0002		
Washer, Crush 10mm	N/A		895518-0001		

### GVW Replacement Part Kits

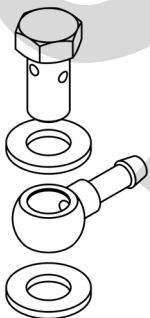

Air Fitting Kit

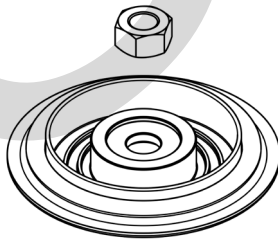

Diaphragm Kit

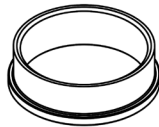

Valve/Bushing Kit

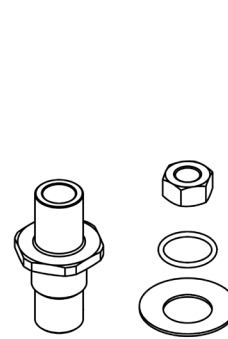

V-Band Inlet | Outlet Kit